

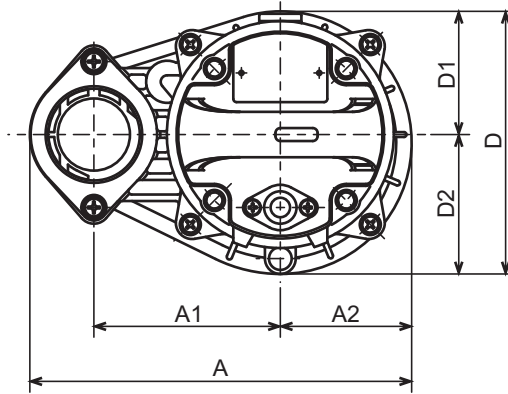

**VANCS-SERIES - PSF**  
(FRP) EFFLUENT PUMPS

**DIMENSIONS**



- 50PSF2.25S-62
- 50PSF2.25-62
- 50PSF2.4S-62
- 50PSF2.4-62
- 50PSF2.75S-62
- 50PSF2.75-62

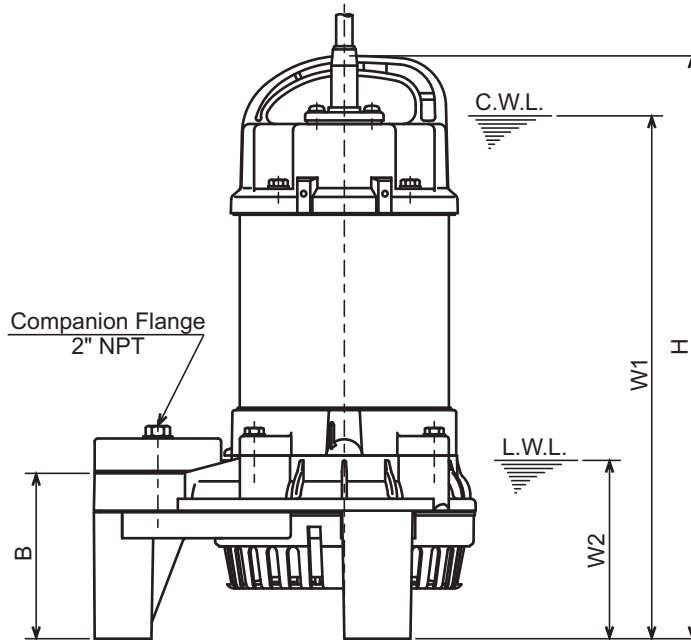

C.W.L. :Continuous running Water Level  
L.W.L. :Lowest running Water Level

**DIMENSIONS:USCS (Inch)**

Model	HP	NOM. SIZE	Pump & Motor								C.W.L. W1	L.W.L. W2	Wt. (lbs.)
			A	A1	A2	B	D	D1	D2	H			
50PSF2.25S-62	1/3	2"	9 5/16	4 1/2	3 3/16	4	6 3/8	3	3 3/8	14 3/16	12 3/4	4 3/8	15.9
50PSF2.25-62	1/3	2"	9 5/16	4 1/2	3 3/16	4	6 3/8	3	3 3/8	13 3/4	12 1/4	4 3/8	13.7
50PSF2.4S-62	1/2	2"	9 5/16	4 1/2	3 3/16	4	6 3/8	3	3 3/8	14 3/16	12 3/4	4 3/8	15.9
50PSF2.4-62	1/2	2"	9 5/16	4 1/2	3 3/16	4	6 3/8	3	3 3/8	14 3/16	12 3/4	4 3/8	15.6
50PSF2.75S-62	1	2"	9 5/16	4 1/2	3 3/16	4	6 3/8	3	3 3/8	14 15/16	13 5/8	4 3/8	19.8
50PSF2.75-62	1	2"	9 5/16	4 1/2	3 3/16	4	6 3/8	3	3 3/8	14 3/4	13 3/8	4 3/8	18.5

**DIMENSIONS:METRIC (mm)**

Model	kW	NOM. SIZE	Pump & Motor								C.W.L. W1	L.W.L. W2	Wt. (kg)
			A	A1	A2	B	D	D1	D2	H			
50PSF2.25S-62	0.25	50	236	115	81	102	162	76	86	360	325	110	7.2
50PSF2.25-62	0.25	50	236	115	81	102	162	76	86	349	310	110	6.2
50PSF2.4S-62	0.40	50	236	115	81	102	162	76	86	360	325	110	7.2
50PSF2.4-62	0.40	50	236	115	81	102	162	76	86	360	325	110	7.1
50PSF2.75S-62	0.75	50	236	115	81	102	162	76	86	380	345	110	9.0
50PSF2.75-62	0.75	50	236	115	81	102	162	76	86	374	340	110	8.4



# VANCS-SERIES - PU / PN / PSF WITH TOK GUIDE RAIL SYSTEM

## DIMENSIONS

**PU / PN / PSF Series**  
**\*1/5 - 1HP**  
 (\*1/5HP only available in PU series)

**Guide Rail System**  
**Model : TOK4-P**

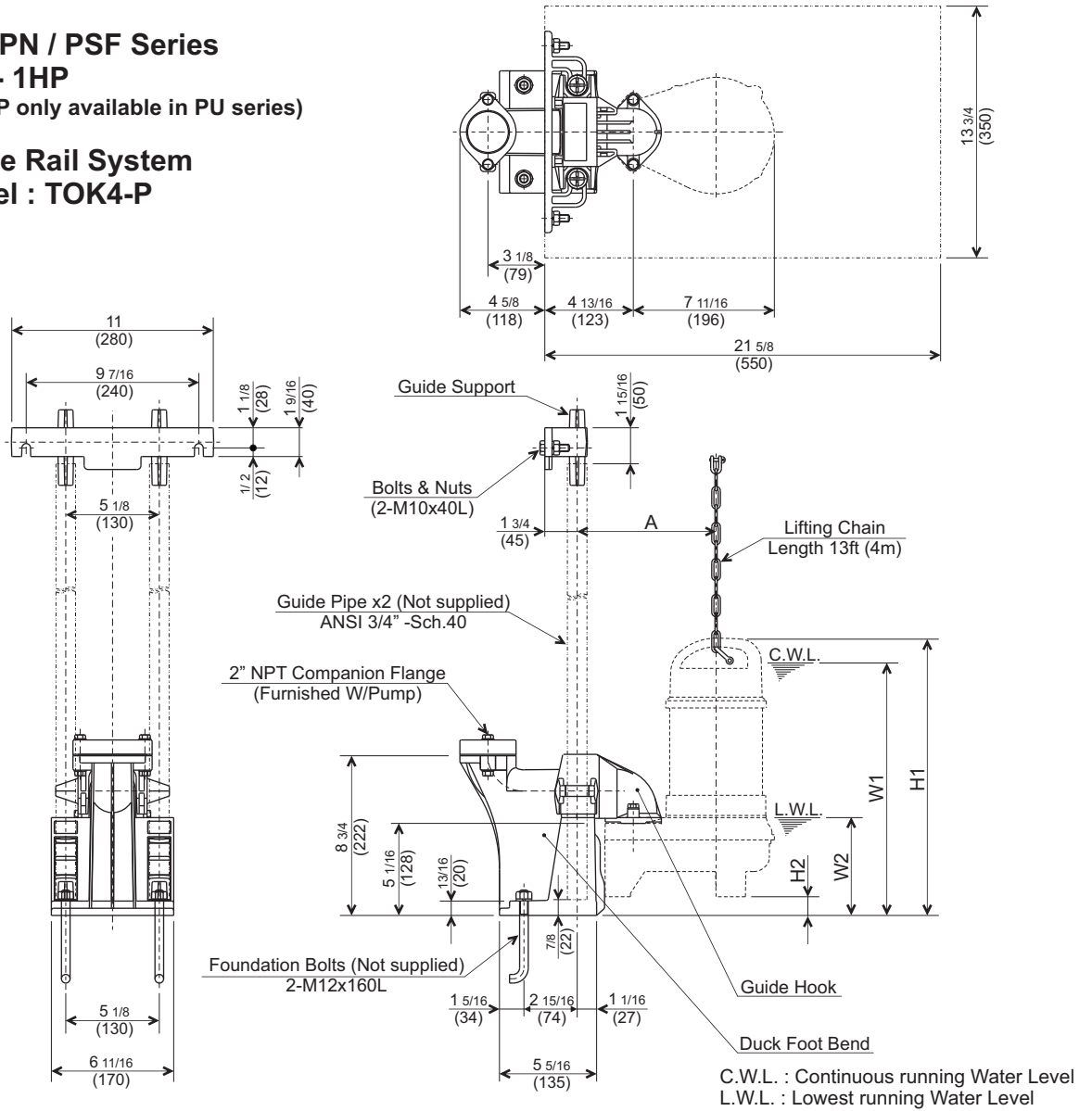

PU SERIES	Model	OUTPUT HP (kW)	NOM. SIZE inch (mm)	Dimension inch (mm)					Wt. lbs. (kg)
				H1	H2	C.W.L.		A	
						W1	W2		
	TOK50PU2.15S-64	1/5 (0.15)	2 (50)	16 1/8 (409)	1 1/4 (32)	14 5/8 (370)	5 3/8 (135)	7 3/8 (188)	14.3 (6.5)
	TOK50PU2.25S-63	1/3 (0.25)	2 (50)	15 3/16 (386)	1 (26)	13 3/4 (350)	5 3/8 (135)	7 5/8 (193)	16.5 (7.5)
	TOK50PU2.25-63	1/3 (0.25)	2 (50)	14 3/4 (375)	1 (26)	13 1/4 (335)	5 3/8 (135)	7 5/8 (193)	14.3 (6.5)
	TOK50PU2.4S-63	1/2 (0.4)	2 (50)	15 3/16 (386)	1 (26)	13 3/4 (350)	5 3/8 (135)	7 5/8 (193)	16.5 (7.5)
	TOK50PU2.4-63	1/2 (0.4)	2 (50)	15 3/16 (386)	1 (26)	13 3/4 (350)	5 3/8 (135)	7 5/8 (193)	16.3 (7.4)
	TOK50PU2.75S-63	1 (0.75)	2 (50)	16 (406)	1 (26)	14 5/8 (370)	5 3/8 (135)	7 5/8 (193)	20.5 (9.3)
	TOK50PU2.75-63	1 (0.75)	2 (50)	15 3/4 (400)	1 (26)	14 1/4 (360)	5 3/8 (135)	7 5/8 (193)	19.2 (8.7)

PN SERIES	Model	OUTPUT HP (kW)	NOM. SIZE inch (mm)	Dimension inch (mm)					Wt. lbs. (kg)
				H1	H2	C.W.L.		A	
						W1	W2		
	TOK50PN2.25S-63	1/3 (0.25)	2 (50)	15 3/16 (386)	1 (26)	13 3/4 (350)	5 3/8 (135)	7 5/8 (193)	16.5 (7.5)
	TOK50PN2.25-63	1/3 (0.25)	2 (50)	14 3/4 (375)	1 (26)	13 1/4 (335)	5 3/8 (135)	7 5/8 (193)	14.3 (6.5)
	TOK50PN2.4S-63	1/2 (0.4)	2 (50)	15 3/16 (386)	1 (26)	13 3/4 (350)	5 3/8 (135)	7 5/8 (193)	16.5 (7.5)
	TOK50PN2.4-63	1/2 (0.4)	2 (50)	15 3/16 (386)	1 (26)	13 3/4 (350)	5 3/8 (135)	7 5/8 (193)	16.3 (7.4)
	TOK50PN2.75S-63	1 (0.75)	2 (50)	16 (406)	1 (26)	14 5/8 (370)	5 3/8 (135)	7 5/8 (193)	20.5 (9.3)
	TOK50PN2.75-63	1 (0.75)	2 (50)	15 3/4 (400)	1 (26)	14 1/4 (360)	5 3/8 (135)	7 5/8 (193)	19.2 (8.7)

PSF SERIES	Model	OUTPUT HP (kW)	NOM. SIZE inch (mm)	Dimension inch (mm)					Wt. lbs. (kg)
				H1	H2	C.W.L.		A	
						W1	W2		
	TOK50PSF2.25S-63	1/3 (0.25)	2 (50)	15 3/16 (386)	1 (26)	13 3/4 (350)	5 3/8 (135)	7 5/8 (193)	17.0 (7.7)
	TOK50PSF2.25-63	1/3 (0.25)	2 (50)	14 3/4 (375)	1 (26)	13 1/4 (335)	5 3/8 (135)	7 5/8 (193)	14.6 (6.6)
	TOK50PSF2.4S-63	1/2 (0.4)	2 (50)	15 3/16 (386)	1 (26)	13 3/4 (350)	5 3/8 (135)	7 5/8 (193)	17.0 (7.7)
	TOK50PSF2.4-63	1/2 (0.4)	2 (50)	15 3/16 (386)	1 (26)	13 3/4 (350)	5 3/8 (135)	7 5/8 (193)	16.5 (7.5)
	TOK50PSF2.75S-63	1 (0.75)	2 (50)	16 (406)	1 (26)	14 5/8 (370)	5 3/8 (135)	7 5/8 (193)	20.7 (9.4)
	TOK50PSF2.75-63	1 (0.75)	2 (50)	15 3/4 (400)	1 (26)	14 1/4 (360)	5 3/8 (135)	7 5/8 (193)	19.4 (8.8)



# VANCS - SERIES - PSF (FRP) EFFLUENT PUMPS

## PERFORMANCE CURVE

MODEL	BORE	HP	KW	RPM	SOLIDS DIA	LIQUID	SG.	VISCOSITY	TEMP.
50PSF(A/W)2.4S-62	2" / 50mm	0.54	0.40	3397	0.315" / 8mm	Water	1.0	1.123 cSt.	60°F
PUMP TYPE		PHASE	VOLTAGE	AMPERAGE		HZ	STARTING METHOD		INS. CLASS
Effluent Pump		Single	115 / 230	5.8 / 2.9		60	Capacitor-Start		E
CURVE No.	DATE	PHASE	VOLTAGE	AMPERAGE		HZ	STARTING METHOD		INS. CLASS
-	-	-	-	-		-	-		-

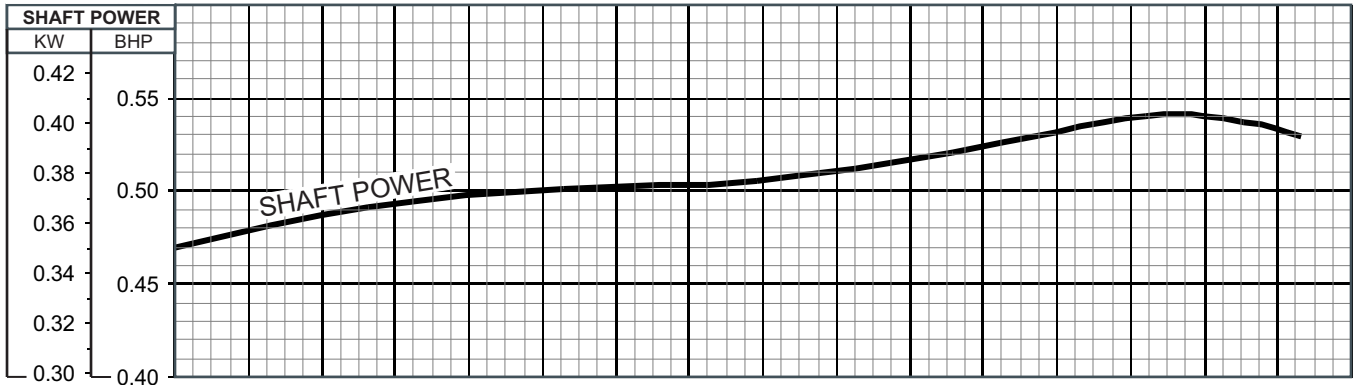
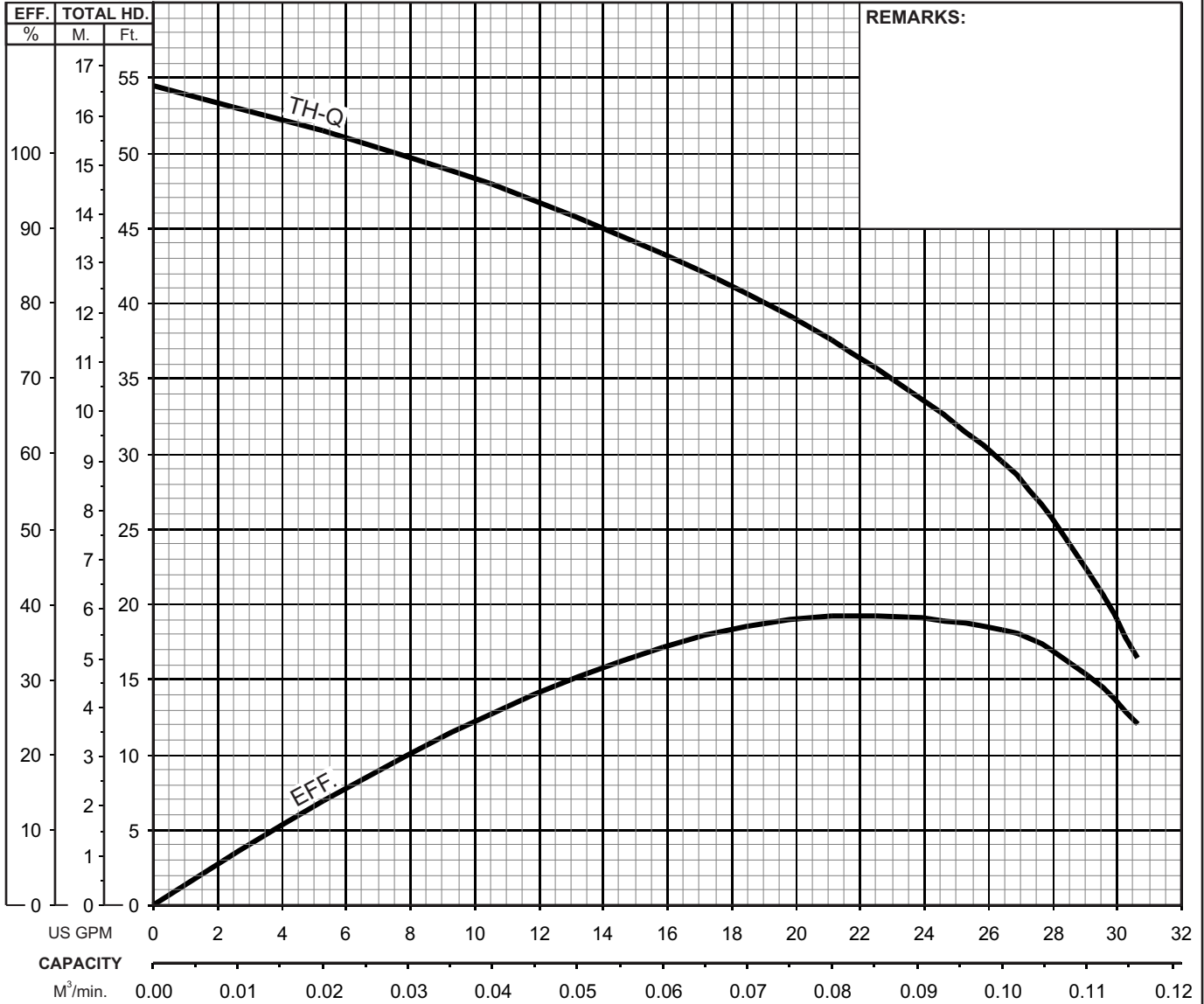



**TSURUMI PUMP**

**VANCS - SERIES - PSF  
(FRP) EFFLUENT PUMPS**

**SECTIONAL VIEW**

**50PSF2.25S-62  
50PSF2.4S-62**

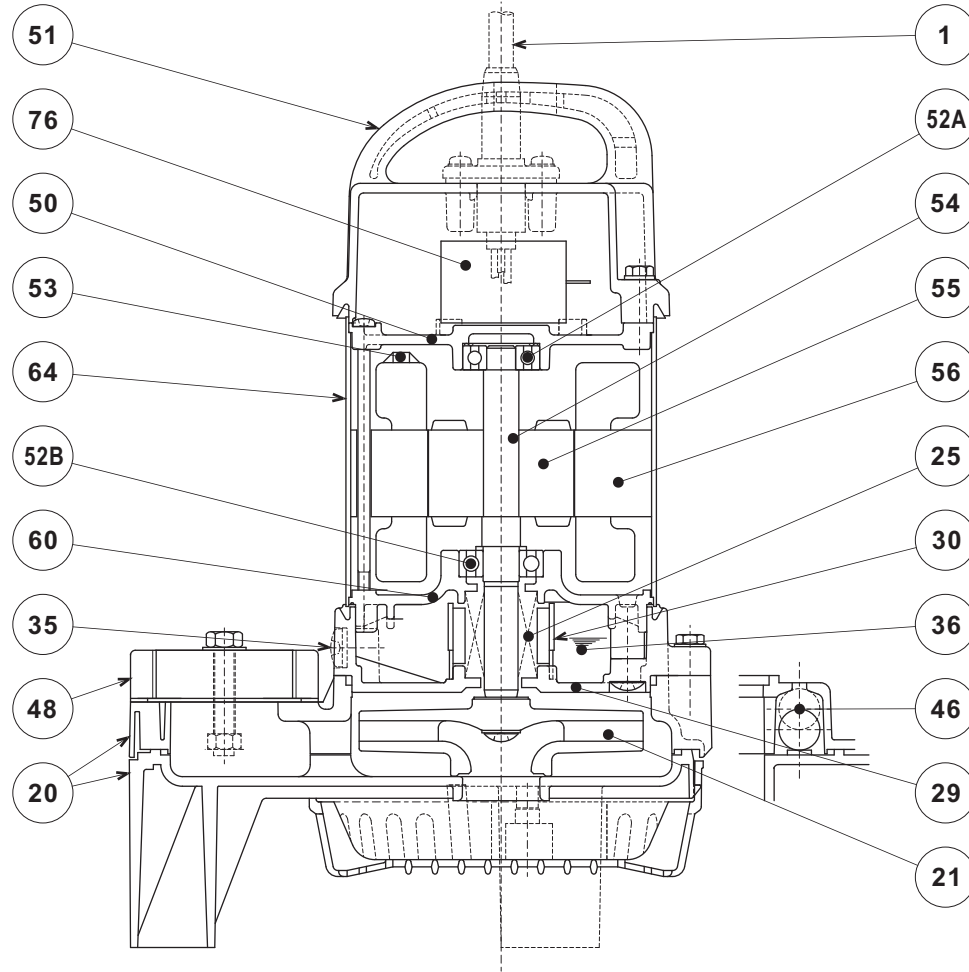

PART#	DESCRIPTION	MAIN MATERIAL / NOTE	RELATED ASTM, AISI CODE	RELATED EN CODE	QTY
1	Power Cable	PVC Sheath AWG16/3-32ft			1
20	Pump Casing	ABS Plastic w/GF20			1
21	Impeller	PPO Plastic w/GF20			1
23	Suction Strainer	ABS Plastic			1
25	Mechanical Seal	Silicon Carbide / W-14HL			1
29	Oil Casing	PPS Plastic w/GF40			1
30	Oil Lifter	PBT Plastic			1
35	Oil Plug	Stainless Steel	S 30400	1.4301	1
36	Lubricant	White Mineral Oil ISO VG32			
46	Air Valve	Glass Ball			1
48	Companion Flange	PBT Plastic w/GF30 / NPT 2"			1
50	Motor Bracket	Aluminum Alloy Die Casting	B85 383.0	EN 1706 AC-46100	1
51	Motor Head Cover	PPS Plastic w/GF40			1
52A	Upper Bearing	#6201ZZC3			1
52B	Lower Bearing	#6202ZZC3			1
53	Motor Protector				1
54	Shaft	Stainless Steel	S 30400	1.4301	1
55	Rotor				1
56	Stator				1
60	Bearing Housing	Aluminum Alloy Die Casting	B85 383.0	EN 1706 AC-46100	1
64	Motor Housing	Stainless Steel	S 30400	1.4301	1
76	Capacitor				1

PARTS LIST		VANCS WASTEWATER PUMP			2/20/2018	
ITEM	PART No.	DESCRIPTION	QTY	SIZE	MATERIAL	NOTES
1	001-943-23	Cabtyre Cable Set (32') 115V-60Hz(USA)	1	STOW3x1.25mm2(CSA)	LB	
	001-000-73	Cabtyre Cable Set (32') 230V-60Hz(USA)	1	STOW3x1.25mm2	LB	
2	143-000-33	Hex.Tapping Screw	2	M5x20	SUS304	
3	003-190-10	Gland	1		SUS316	
4	051-000-46	Head Cover	1		Resin	
5	140-000-07	Hex.Bolt (w/Plain Washer)	4	M6x30(22L)	SUS304	
6	122-004-18	O-Ring	4	P-6(5.8xd1.9)	NBR	*
7	143-085-34	Pan Screw (w/Spring Washer)	1	M4x6	C3604	
8	009-001-25	Earth Terminal	1Set	AWG16x170L		
9	076-000-01	Capacitor 115V-60Hz(USA)	1	45MF-220VAC		
	076-000-08	Capacitor 230V-60Hz(USA)	1	12MF-440VAC		
10	143-000-04	Pan Screw	4	M5x118(20L)	SWRM	
11	050-000-02	Motor Bracket	1		ADC	
12	121-001-46	Packing	1	d125.7xd134.7x6t	NBR	*
13	056-007-91	Stator(w/M.Frame) 115V-60Hz(USA)	1Set	w/Miniature Protector		
	056-007-93	Stator(w/M.Frame) 230V-60Hz(USA)	1Set	w/Miniature Protector		
14	071-000-01	Collar	1	37L	SECC	
15	142-000-91	Wave Washer	1	6201(D=30.6,t=0.35)	SK5	
16	052-100-15	Bearing	1	6201ZZC3		
17	055-002-90	Rotor	1Set	w/Bearing		
18	061-157-15	Bearing Collar	1	d15.1xd21x1.6t	SPCC	
19	052-101-16	Bearing	1	6202ZZC3		
20	060-001-36	Bearing Housing	1		ADC	
21	025-000-18	Mechanical Seal	1	W-14HC	SSiC	
22	030-000-01	Oil Lifter	1	VANCS2	Resin	
23	121-001-12	Packing	1	VANCS2	NBR	*
24	035-127-15	Oil Plug	1	M10x15	SUS304	
25	121-246-11	Packing	1	d10.3xd16x2t	PE	*
26	140-000-03	Hex.Bolt (w/Spring Washer)	4	M6x25	SUS304	
27	029-000-95	Oil Casing	1	VANCS2	Resin	
28	143-000-26	Truss Screw (w/O-Ring)	4	M6x20(P-5,NBR)	SUS304	
29	142-354-18	Conical Spring Washer	1	d11.2xd22.5x0.8t	SUS304	
30	021G3127	Impeller (60Hz)	1	50PSF2.4S-63	Resin	
31	143-140-12	Truss Screw (w/Plain Washer)	1	M6x12	SUS304	
32	122-000-07	O-Ring	1	122xd3.0	NBR	*
33	140-000-09	Hex.Bolt (w/Spring Washer)	2	M8x45	SUS304	
34	048-274-18	Screwed Flange	1	NPT-2(P.C.90)	Resin	
35	121-469-12	Packing	1	P.C.90xd58x2t	NR	*
36	020-000-06	Pump Casing	1	(40/50)PN/PSF2.25/.4/.75	Resin	



MODEL 50PSF2.4S-63

PARTS LIST		VANCS WASTEWATER PUMP				2/20/2018
ITEM	PART No.	DESCRIPTION	QTY	SIZE	MATERIAL	NOTES
37	023-000-02	Strainer	1	(40/50)PSF(A)(W)2.25/.4/.75	Resin	
38	143-000-10	Truss Tapping Screw	2	M4x18	SUS304	
	173-003-14	<b>Packing O-Ring Set</b>	1Set	(Marked by *)		
6	122-004-18	O-Ring (Head Cover Fixing Bolt)	4	P-6(5.8xd1.9)	NBR	*
12	121-001-46	Packing (Head Cover/M.Frame)	1	d125.7xd134.7x6t	NBR	*
23	121-001-12	Packing (M.Frame/O.Casing)	1	VANCS2	NBR	*
25	121-246-11	Packing (Oil Plug)	1	d10.3xd16x2t	PE	*
28	122-003-17	O-Ring (P.Casing Fixing Screw)	4	P-5(4.8xd1.9)	NBR	*
32	122-000-07	O-Ring (O.Casing/P.Casing)	1	122xd3.0	NBR	*
35	121-469-12	Packing (Screwed Flange)	1	P.C.90xd58x2t	NR	*
		Lubricant		Liquid Paraffin VG32 240ml		

PARTS LIST		VANCS WASTEWATER PUMP			2/20/2018	
ITEM	PART No.	DESCRIPTION	QTY	SIZE	MATERIAL	NOTES

## EXPLODED VIEW

50PSF2.25S-52/62  
 50PSF2.25S-53/63  
 50PSF2.4S-52/62  
 50PSF2.4S-53/63

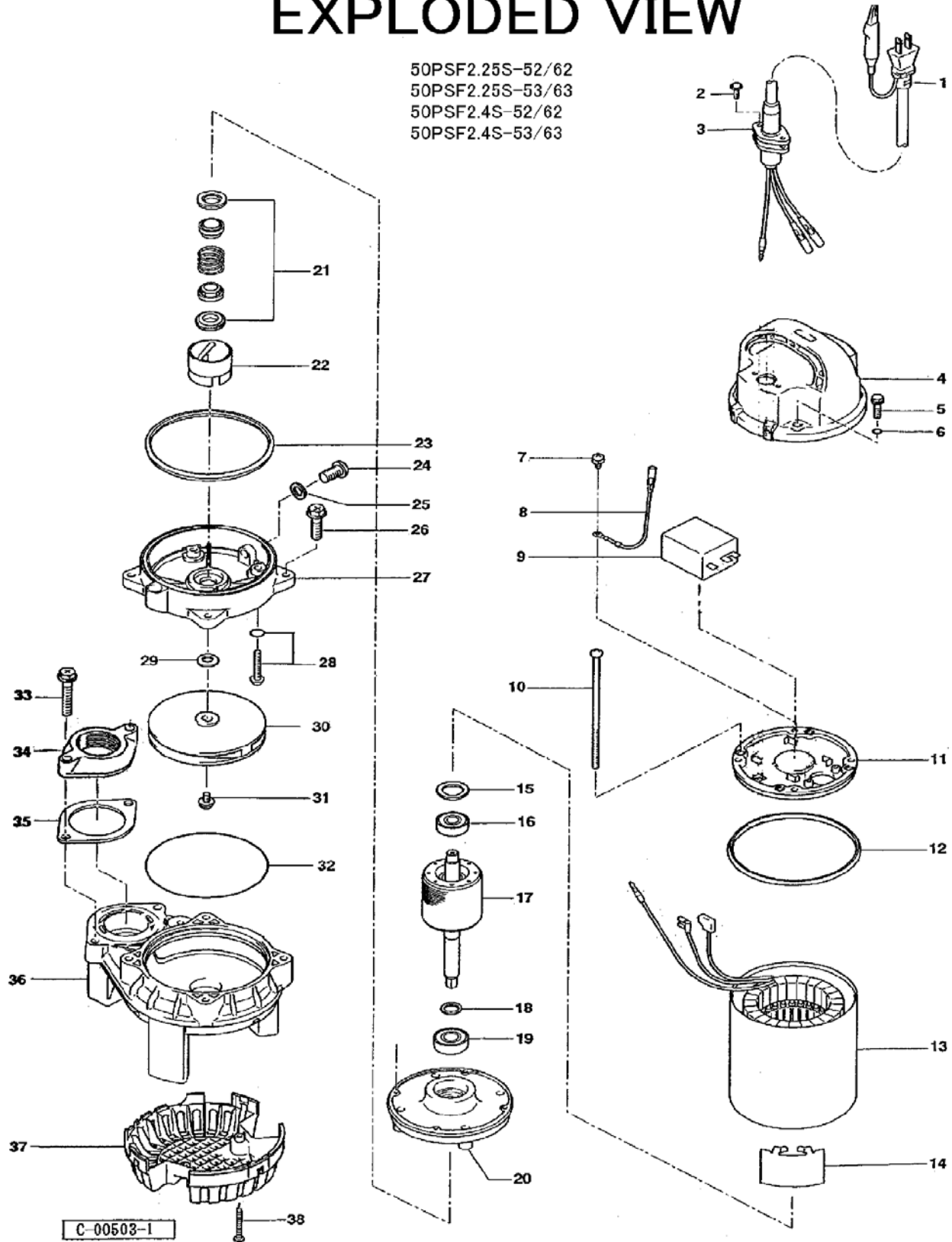

C-00503-1